

Frame Size 24mm/42mm/60mm/85mm Shaft Type Motor Frame Size 42mm/60mm/85mm Built-in brake type Motor

Features

- Compact design and light weight with high accuracy, speed and torque
- Suitable for small-sized equipment applications
- Frame size 42mm/60mm/85mm built-in brake of shaft type for compact equipment (AK-B Series)
- Brake force is released (AK-B Series) when applying power on brake wire
- Cost-effective

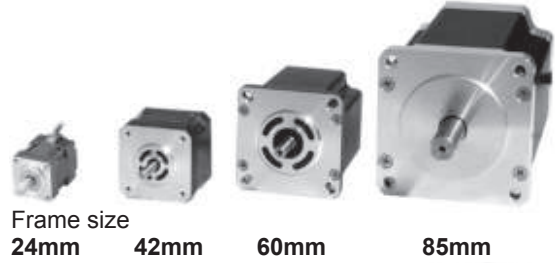

Frame size 24mm 42mm 60mm 85mm

⚠ Please read "Safety Considerations" in operation manual before using.



Frame size 42mm Brake built-in type 60mm Brake built-in type 85mm Brake built-in type

Dimensions

- ※ These dimensions are for dual shaft models. Single shaft models do not include shafts indicated in the dotted lines.
- ※ For flexible coupling (ERB series) information, refer to F-80. (frame size 24mm, 48mm, 60mm (shaft type))
- ※ Brake is non-polar and be sure to observe rated excitation voltage (24VDC). (except frame size 24mm)
SW1 ON: brake release / SW1 OFF: brake execute

Frame size 24mm

(unit: mm)

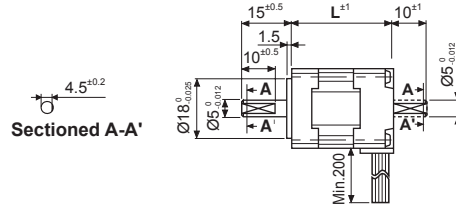
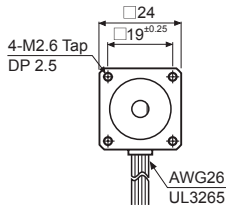

Model	L
02K-S523(W)	30.5
04K-S525(W)	46.5

(unit: mm)

Frame size 42mm

(unit: mm)

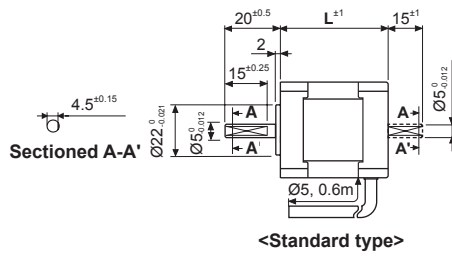
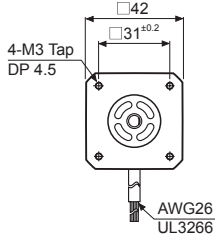

Model	L
A1K-S543(W)-[B]	33
A2K-[]544(W)-[B]	39
A3K-S545(W)-[B]	47

(unit: mm)

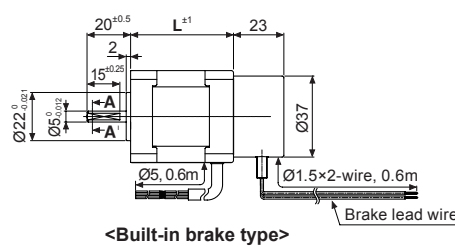
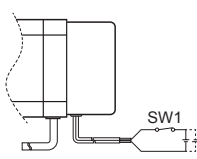

- (A) Photoelectric Sensors
- (B) Fiber Optic Sensors
- (C) Door/Area Sensors
- (D) Proximity Sensors
- (E) Pressure Sensors
- (F) Rotary Encoders
- (G) Connectors/ Connector Cables/ Sensor Distribution Boxes/Sockets
- (H) Temperature Controllers
- (I) SSRs / Power Controllers
- (J) Counters
- (K) Timers
- (L) Panel Meters
- (M) Tacho / Speed / Pulse Meters
- (N) Display Units
- (O) Sensor Controllers
- (P) Switching Mode Power Supplies
- (Q) Stepper Motors & Drivers & Controllers
- (R) Graphic/ Logic Panels
- (S) Field Network Devices
- (T) Software

AK/AK-B Series

■ Dimensions

◎ Frame size 60mm

(unit: mm)

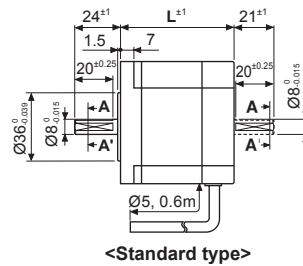
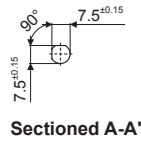
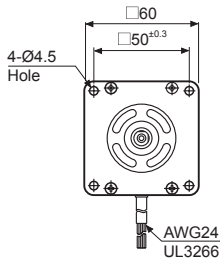

(unit: mm)

Model	L
A4K-□564(W)-□B	48.5
A8K-□566(W)-□B	59.5
A16K-□569(W)-□B	89

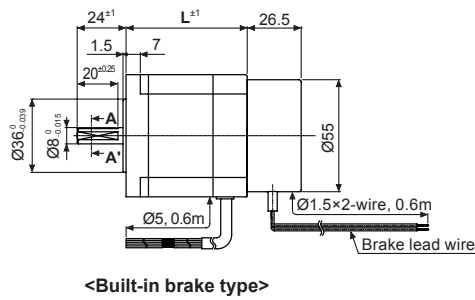
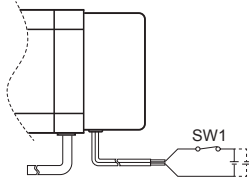

◎ Frame size 85mm

(unit: mm)

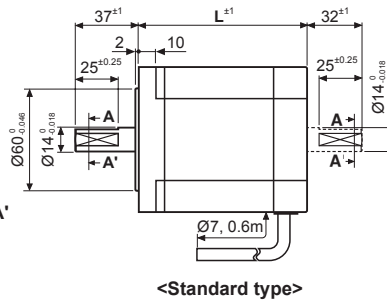
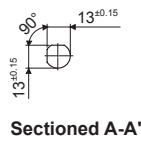
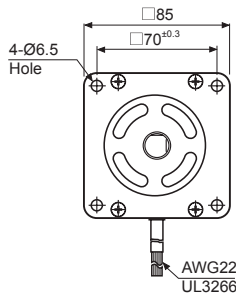

Model	L
A21K-□596(W)-□B	68
A41K-□599(W)-□B	98
A63K-□5913(W)-□B	128

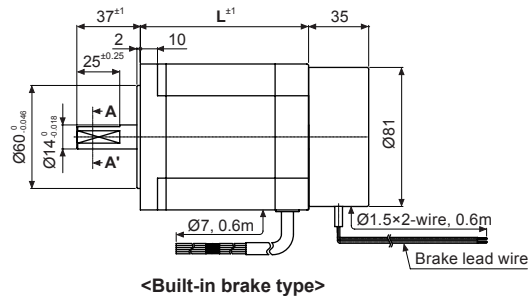
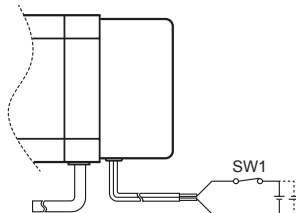

5-Phase Stepper Motor

Characteristic

● 02K-S523

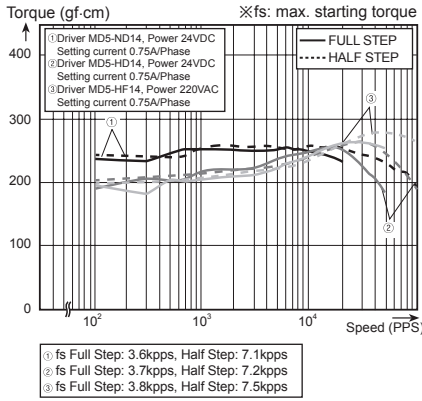

● 04K-S525

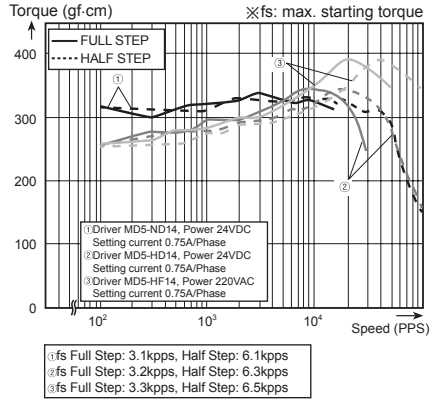

● A1K-S543 / A1K-S543-B

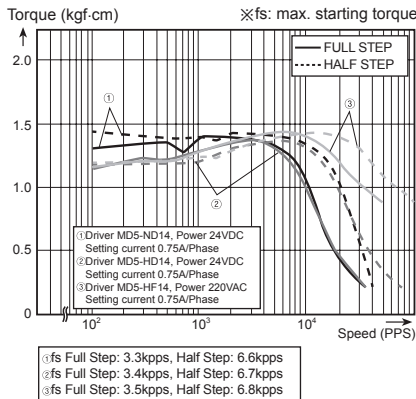

● A2K-□544 / A2K-□544-B

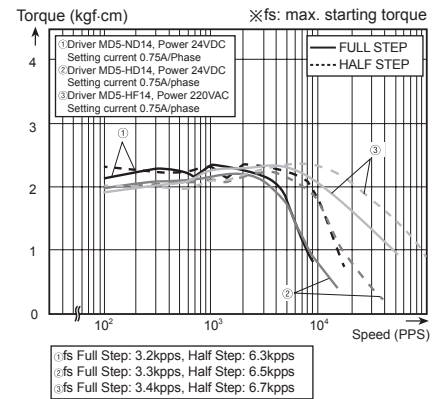

● A3K-S545 / A3K-S545-B

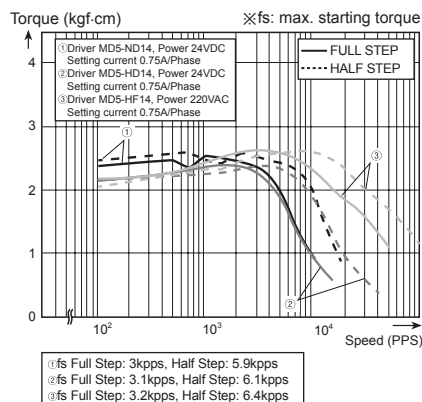

● A4K-□564 / A4K-M564-B

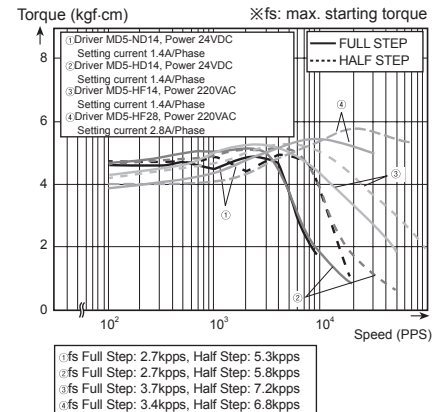

(A)	Photoelectric Sensors
(B)	Fiber Optic Sensors
(C)	Door/Area Sensors
(D)	Proximity Sensors
(E)	Pressure Sensors
(F)	Rotary Encoders
(G)	Connectors/ Connector Cables/ Sensor Distribution Boxes/Sockets
(H)	Temperature Controllers
(I)	SSRs / Power Controllers
(J)	Counters
(K)	Timers
(L)	Panel Meters
(M)	Tacho / Speed / Pulse Meters
(N)	Display Units
(O)	Sensor Controllers
(P)	Switching Mode Power Supplies
(Q)	Stepper Motors & Drivers & Controllers
(R)	Graphic/ Logic Panels
(S)	Field Network Devices
(T)	Software

AK/AK-B Series

Characteristic

● A8K-□566 / A8K-M566-B

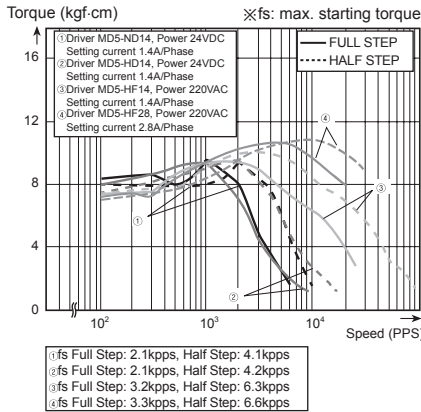

● A16K-□569 / A16K-□569-B

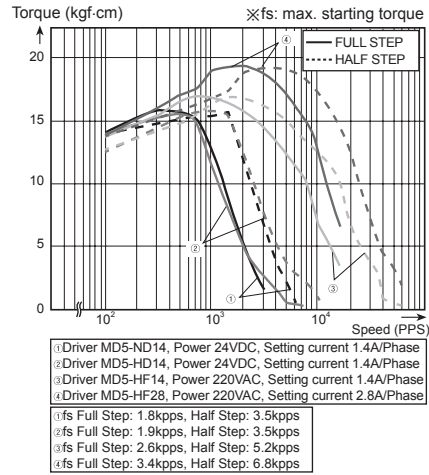

● A21K-□596 / A21K-□596-B

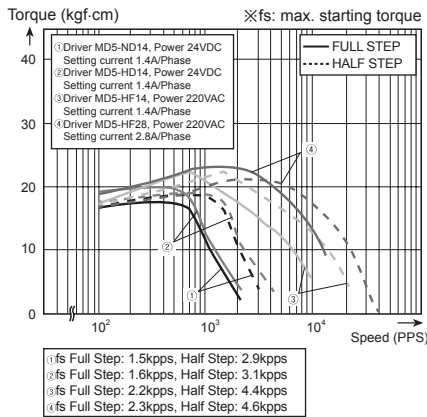

● A41K-□599 / A41K-□599-B

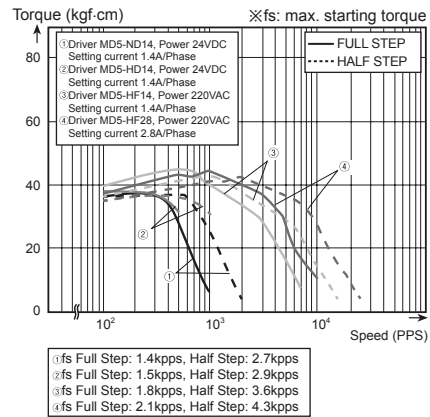

● A63K-□5913 / A63K-□5913-B

